

RTC^t-156/157

Reference Temperature Calibrator

Temperature range: -32 to 155°C/-26 to 311°F (RTC^t-156)
and -45 to 155°C/-49 to 311°F (RTC^t-157)

Accuracy down to: $\pm 0.040^{\circ}\text{C}/\pm 0.081^{\circ}\text{F}$
with External Reference Sensor*



Designed for Versatility

The RTCt models ushers in a new era of precision and user-centricity in temperature calibration by offering a comprehensive feature set meticulously designed to improve your workflows. Experience the easy intuitive navigation through the touchscreen interface. Wireless connectivity streamlines data transfer and facilitates remote monitoring while innovative graphical presentations enhance clarity and expedite analysis.

The RTCt-156 and RTCt-157 provide the optimal combination of exceptional accuracy, stability and speed in the temperature range. The features and benefits of the popular RTC series are maintained in the RTCt series, to name a few:

- Patented DLC (Dynamic Load Compensation) system for perfect temperature uniformity in the insert.
- Fast heating and cooling to reduce calibration time.
- Lightweight and easy to carry around.
- High profile design and well-known, long lasting Jofra quality.



Advanced Touchscreen Display: Provides a highly intuitive navigation, operation and all relevant data at your fingertips. Experience clear numerical values, step-by-step instructions, and graphical representations that elevate your calibration process.

Wireless Connectivity: Experience seamless data access and sharing. Monitor, control and analyze calibration data in real-time through a web browser interface, from anywhere in your facility or even remotely. This wireless functionality reduces the need to be physically present at the calibrator, saving time and ensuring efficient calibration processes.

Two Sensor Under Test Inputs: With the ability to simultaneously calibrate two sensors, the RTCt-156 and RTCt-157 offer a comprehensive solution for even complex calibrations effectively doubling the calibration capacity per run.

Designed for Versatility: The RTCt-156 and RTCt-157 are essential tools across industries such as pharmaceuticals, food and beverage, aerospace, automotive, and power generation. These calibrators ensure precise and reliable sensor calibration for regulated environments, high-throughput manufacturing, and critical quality control, meeting the demands of both laboratory and field applications with unmatched accuracy and ease of use.

Intelligent Reference Sensors: Jofra reference sensors are supplied with intelligent plugs, holding the calibration data (coefficients, serial number and calibration date) of the reference sensor. This is a truly plug n' play calibration system.

Enhanced Efficiency, Time and Sustainability: The RTCt-156 and RTCt-157 temperature calibrators are designed with enhanced sustainability features, prioritizing efficiency and reducing environmental impact. Compared to previous models, both the RTCt-156 and RTCt-157 offer shorter cooling times, reducing overall operational time for each calibration. Additionally, their optimized power consumption lowers energy usage while maintaining top-tier performance.

EURAMET: Best performing dry-block with regard to the EURAMET/cg-13 guideline for the testing of dry-blocks.

Optimized Calibration Workflows

The RTCt temperature calibrator prioritizes user experience through innovative features that streamline workflows and empower technicians. This section details how the RTCt enhances calibration efficiency through user-defined setpoints, configurable interfaces, and intuitive data management.

User-Defined Setpoints for Streamlined Calibration

The RTCt provides enhanced control over your calibration process with its user-defined "Preset Temperatures" functionality. Define up to six custom temperature points to precisely match your specific sensor requirements. This eliminates the need for repetitive re-entries of often used calibration temperatures, which is streamlining workflow and maximizing efficiency.

User-Configurable Interface for Optimized Workflow

The RTCt surpasses traditional interfaces by offering a customizable user experience that adapts to your workflow. Leveraging the selectable User Interface (UI) feature, prioritize the information most critical for your tasks, minimizing distractions and enhancing focus. Tailor the interface to your preferences, ensuring intuitive and effortless execution of each calibration step. This results in a personalized calibration process that seamlessly integrates with your existing workflow.

Intuitive Data Management for Effortless Retrieval

The RTCt improves data management by introducing a user-definable data naming convention. Eliminate confusion from generic labels by implementing a system that reflects your unique calibration procedures. Assign meaningful names to your data sets, enabling effortless searching and retrieval. Say goodbye to time-consuming data mining and streamline your calibration workflow with the RTCt's intuitive data management capabilities.



Enhanced Connectivity and Wireless Capabilities

Unrestricted Calibration from Anywhere

The RTCt temperature calibrator's wireless connectivity empowers you to calibrate with unprecedented freedom and flexibility. With Wi-Fi capabilities, you can monitor and analyze calibration data in real-time through a web browser interface, from anywhere in your facility or even remotely. This wireless functionality eliminates the need to be physically present at the calibrator, saving time and ensuring efficient calibration processes.

Effortless Remote Management via Web Interface

For wireless connectivity, the RTCt includes a Wi-Fi dongle, allowing cable-free operation and remote access. This Wi-Fi connection enhances workflow automation, reduces setup constraints, and ensures seamless integration into your calibration environment.

Enhance Versatility through Diverse Communication Standards

The RTCt caters to various connectivity needs by supporting a wide range of communication standards, including Wi-Fi, Ethernet, and USB. This comprehensive offering ensures seamless integration with existing systems, regardless of their communication protocol.

Simplified Integration with User-Friendly Communication Protocols

Seamlessly integrate the RTCt into your existing systems with open communication protocols, ensuring flexibility across industries such as pharmaceutical, food & beverage, energy, and manufacturing. The RTCt supports ASCII-based protocol, making integration effortless across various platforms.

By offering open protocols, the RTCt eliminates compatibility challenges, allowing for smooth automation, remote control, and data exchange with external systems.



The Wi-Fi dongle is standard equipment in all RTCts

Redefining Precision and Intuitiveness: Unveiling the RTC^t Temperature Calibrator's Touch Screen User Interface

In a groundbreaking stride toward user-centric innovation, we are thrilled to introduce the RTC^t Temperature Calibrator's all-new Touch Screen User Interface. This cutting-edge interface marks a pivotal moment in temperature calibration technology, seamlessly merging precision with unparalleled intuitiveness. Designed with user experience at its core, the RTC^t's touch screen interface heralds a new era in temperature calibration, promising a more accessible, efficient, and user-friendly calibration process. Let's explore the transformative features that make this touch screen interface a game-changer for professionals in the field.

The RTC^t startup menu provides a simple and user-friendly interface, ensuring quick access to essential functions. Users can effortlessly select between: Calibration / Auto Calibration / Switch Test / Auto Step.



The RTC^t main screen provides a clear, real-time view of the ongoing calibration with live progress, setpoints, and stability indicators. The intuitive graph dynamically adjusts for enhanced precision and deviation detection. Learn more on the [next page](#).

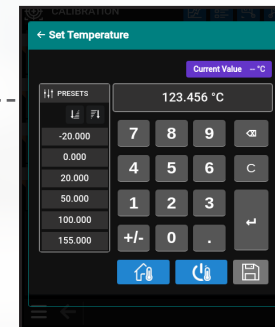

Easily set and manage calibration temperatures with six customizable presets for quick selection. Effortlessly prepare for storage temperature setting for future use. The controller ON/OFF function provides seamless control, ensuring efficient operation and precision.

The RTC^t UI ensures a clear and intuitive input experience, with active inputs highlighted in green and unavailable selections greyed out, eliminating any risk of incorrect connections.

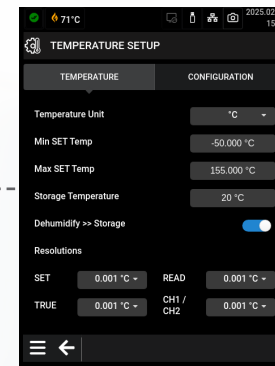
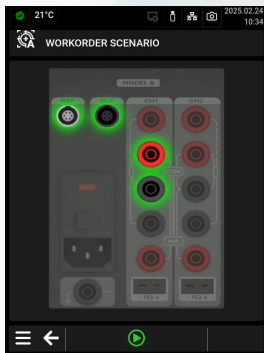

Easily configure system, temperature, and communication settings with an intuitive interface.

Patent Pending

RTC^t Series – Reliable Calibration with Complete Peace of Mind

See Every Detail. Trust Every Result. Calibrate with Confidence.

When precision matters, you need more than just numbers – you need visual proof that your calibration is accurate, stable, and reliable. The RTC^t Series Temperature Calibrators provide real-time dynamic graphing and patented innovations that make it easier than ever to verify accuracy, detect deviations, and ensure full compliance.

Exclusive Real-Time Calibration Graph – Patent Pending

Traditional calibrators can plot temperature over time, but they don't adapt dynamically. The RTC^t Series introduces the first-ever real-time graphing system that adjusts automatically based on calibration stability.

- **Instant Overview of the Calibration Process:** The calibration process begins with a broad full-cycle graph, which provides a clear, real-time view of your calibration's progression, helping users track temperature trends at a glance.
- **Setpoint Reference Line:** A dedicated line marks your set temperature, so you can instantly see when the calibrator reaches and maintains stability.
- **Automatic Precision Mode for Unmatched Visibility:** Once the calibrator reaches the setpoint and meets the stability criteria, the RTC^t's graph intelligently shifts to a high-resolution relative view, magnifying even the smallest deviations.
- **Unmatched Deviation Visibility:** The relative graph magnifies even the smallest variations, making it possible to detect tiny fluctuations that are otherwise difficult to see.
- **Patent-Pending Technology:** Only in RTC^t – No other calibrator dynamically adjusts its graph based on calibration stability, giving you unrivaled visual confidence in your results.
- **Customizable Display:** All blue icons at the top of the screen can be easily toggled on or off, allowing users to focus only on the most relevant calibration data. This flexibility ensures a clutter-free interface tailored to individual workflows.
- **Seamless Documentation:** With a single tap of the print screen button, all on-screen information is instantly documented, preserving calibration data and highlighting even the most minute fluctuations for post-analysis.

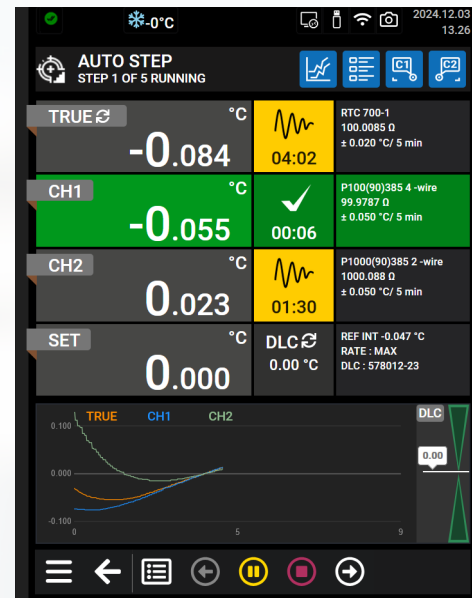

See the entire calibration process at a glance, with a clear setpoint reference line for easy stability monitoring.

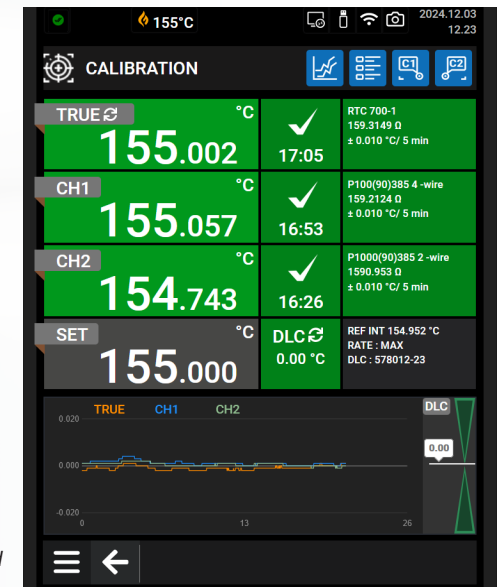

Automatically zooms in on micro-deviations once stability is reached, ensuring unmatched accuracy and confidence.

Precision Switch Testing – Clear, Reliable, and Fully Documented

Temperature switches are critical for safety, system control, and process reliability. Ensuring they activate at the correct setpoints is essential to prevent false alarms, avoid equipment failures, and minimize costly downtime. The RTCt Series takes switch testing to the next level with an advanced, highly visual switch test display, delivering instant clarity, precision, and comprehensive documentation.

Switch Testing Made Clear and Reliable

■ Graph and Table Data on One Screen:

The RTCt displays both the switch test graph and the test results table simultaneously. The graph plots switch activation points over time, making it easy to detect drift, response delays, or anomalies. The table logs exact activation and deactivation temperatures, ensuring precise traceability.

■ Hysteresis & Repeatability Analysis:

Understanding switch behavior isn't just about activation temperature; it's also about how consistently it triggers under repeated cycles. The RTCt makes it simple to see:

Hysteresis – The difference between activation and reset points.

Switch consistency – Does it switch at the same temperature every time?

■ Documentation at the Push of a Button

With built-in print screen functionality, all displayed information – including graphs, test results, and activation trends – can be instantly documented for audits, compliance, and traceability.

The RTCt's advanced switch test display transforms temperature switch verification into a clear, reliable, and fully traceable process – helping users enhance safety, reduce downtime, and optimize operational efficiency.

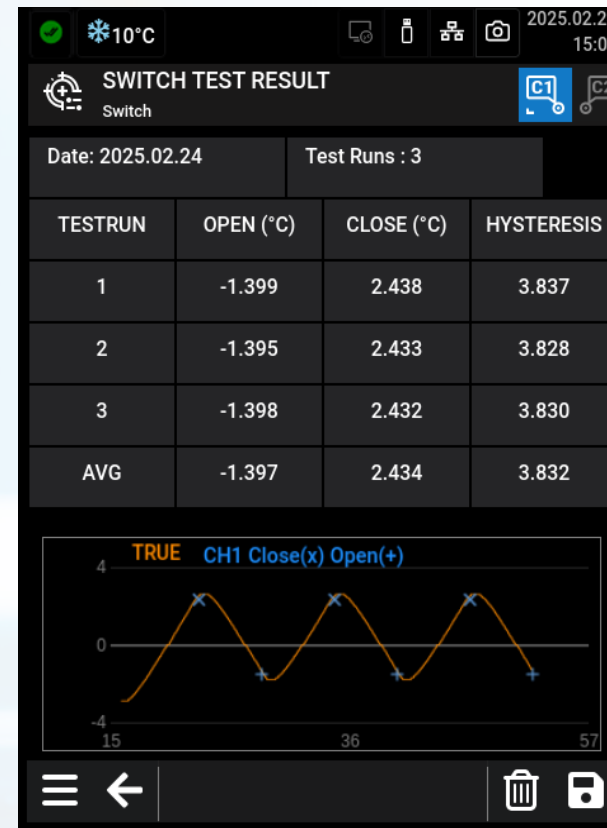

Track switch activation points with dynamic status indicators, a real-time graph, and precise test results—all in one clear, intuitive display.

Precision Calibration through Dual-Zone and DLC Technology

The RTCt-156 and RTCt-157 models set new standards for precision and uniformity in temperature calibration, thanks to AMETEK's proprietary Dual-Zone Heating Technology, Dual-Sensor calibration, and Dynamic Load Compensation (DLC) system. These advancements work together to ensure unparalleled temperature stability across the calibration zone, supporting complex and high-accuracy calibration needs.



Active Dual-Zone Heating Technology

This innovative feature allows independent control over two heating zones within the calibration block, providing a precisely regulated environment. By maintaining consistent temperatures across both zones, the calibrator can minimize temperature gradients, even with variable sensor sizes or types. This technology is particularly valuable in applications where uniformity is critical, such as pharmaceuticals and quality control laboratories.

The RTCt Series can perform calibration over a very wide temperature range starting from -57°C and up to 155°C (-71 to 311°F). This makes it possible to perform calibration jobs over a range of 219° C (382° F). See full specifications on page 16.

Dual-Sensor Input for Parallel Calibration

The RTCt-156 and RTCt-157 empowers users to simultaneously calibrate two sensors, significantly boosting efficiency and productivity. This dual-input system eliminates the need for sequential calibration, allowing for parallel processes that streamline workflows and reduce downtime.

Patented Dynamic Load Compensation (DLC)

The DLC system dynamically adjusts for any thermal inconsistencies that may arise from different sensor loads or large sensor arrays. By continuously monitoring and compensating for load variations, DLC technology creates an exceptionally homogeneous temperature field. This capability allows for 'close-to-laboratory' performance, even in challenging industrial settings where diverse sensors are calibrated simultaneously.

DLC Indicator for Real-Time Monitoring

The RTCt screen features a Dynamic Load Compensation (DLC) indicator, providing instant feedback on calibration stability. Users can set custom DLC values, ensuring precise control over load compensation.

The DLC status is clearly displayed in three formats:

- **Visual Diagram** – Instantly track stability with a graphical representation.
- **Color Indicators** – Green (within threshold), Yellow (outside threshold), and Grey (no check for DLC threshold) for quick assessment. (The DLC threshold functionality is a patent pending feature.)
- **Data Table** – Numerical values provide detailed insights for accurate calibration decisions.

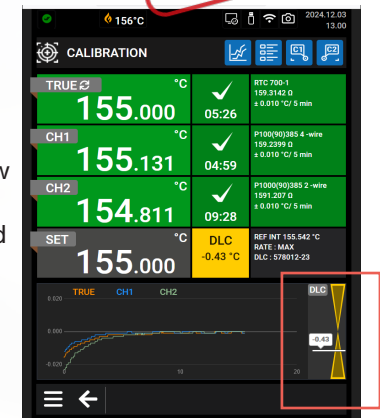

Visual of the DLC status

Enhanced Precision for Large or Multiple Sensors

The combination of dual-zone control and DLC technology makes the RTCt-156 and RTCt-157 ideal for calibrating large sensors or multiple sensors in a single run. By maintaining uniform heat distribution, these calibrators ensure that each sensor experiences the same stable temperature, regardless of load or configuration, leading to faster calibration and greater confidence in the results.

Why Dual-Zone and DLC Matter

These technologies address common issues like temperature inhomogeneity and uneven sensor heating, which can lead to errors in calibration results. With Dual-Zone and DLC, the RTCt-156 and RTCt-157 provide a level of stability and accuracy that meets even the most stringent industry standards, from EURAMET guidelines to specific regulatory requirements. This makes them invaluable tools for industries where accurate, repeatable calibration is essential, enabling users to achieve high-quality outcomes that support compliance and operational excellence.

Intelligent Reference Sensors, Unique Sensor Design, and Multi-Hole Insert Kits

The RTCt-156 and RTCt-157 temperature calibrators come equipped with specialized features that enhance their precision, versatility, and ease of use. These include intelligent reference sensors, uniquely designed sensors for varied applications, and multi-hole insert kits, all of which contribute to efficient and reliable calibration for a diverse range of sensor types and sizes.

Intelligent Reference Sensors for Seamless Accuracy

Each intelligent reference sensor stores its calibration data directly within the sensor itself, enabling true plug-and-play calibration. By automatically communicating its unique calibration coefficients to the RTCt unit, the sensor minimizes setup time, reduces error potential, and simplifies recalibration workflows. This innovation ensures every calibration is precise and traceable, supporting compliance with rigorous industry standards and reducing the need for manual data entry.



Unique Sensor Design for Enhanced Versatility

The STS-200 reference sensors and the DLC sensors have been specially designed. They are both angled 90° and have been customized to fit the calibrator so they are only slightly higher than the top of the RTC calibrator. The unique design makes it possible to calibrate threaded sensors and sensors with connection heads without any problems.



Sanitary Sensor and Insert.

Multi-Hole Insert Kits for Adaptable Calibration

For users who frequently calibrate different sensor sizes, the multi-hole insert kits are an invaluable addition. Each kit includes a variety of pre-drilled inserts, covering the most common sensor diameters without requiring multiple individual inserts. Metric and imperial insert options are available, ensuring that each calibration session is efficient and hassle-free. The inserts are designed to accommodate both standard reference sensors and DLC sensors, offering a consistent temperature environment that maintains the homogeneity needed for high-precision calibrations.



The Benefits of Modular Accessories

These modular, user-friendly accessories make the RTCt-156 and RTCt-157 calibrators adaptable to almost any calibration setup. With intelligent sensors that self-configure, specially designed reference sensors for diverse installations, and flexible multi-hole inserts, these calibrators provide users with a highly versatile solution for accurate and streamlined temperature calibration.

Enhanced Stability, Accuracy, and Support Features

The RTCt-156 and RTCt-157 temperature calibrators are equipped with innovative support and stability features that maximize accuracy, ease of use, and operational efficiency. These features make them indispensable tools for industrial environments requiring precise and repeatable calibration results.

Auto Stepping for Efficient Multi-Step Calibration

The RTCt-156 and RTCt-157 feature an Auto Stepping function, which allows users to pre-program up to 20 temperature steps, with customizable hold times at each step. This hands-off approach enables efficient multi-step calibrations, reducing manual intervention and providing consistent, repeatable results for complex applications. For labs and production environments that require repeat calibrations across set temperatures, auto stepping is particularly useful.

Switch Test Mode for Thermo-switch Calibration (Model B Only)

The Switch Test function on Model B streamlines thermo-switch calibration by automatically identifying Open and Closed states, as well as measuring the hysteresis (deadband). With automatic capture of up to twenty test results, this feature is ideal for precise calibration of temperature switches, saving time and ensuring high repeatability, even across complex calibration routines.

Highest Accuracy Calibration with Set-Follows-True (Models B & C)

Models B and C of the RTCt-156 and RTCt-157 deliver maximum accuracy through their unique Set-Follows-True function. This feature adjusts the calibration setpoint based on real-time readings from the external reference sensor, ensuring that the calibration zone temperature matches the target precisely. Set-Follows-True is especially valuable when accuracy is critical, as it eliminates the need for manual adjustments and delivers unmatched precision in every calibration.

Set Follows True and dual-zone technology make dry sanitary sensor calibration possible.

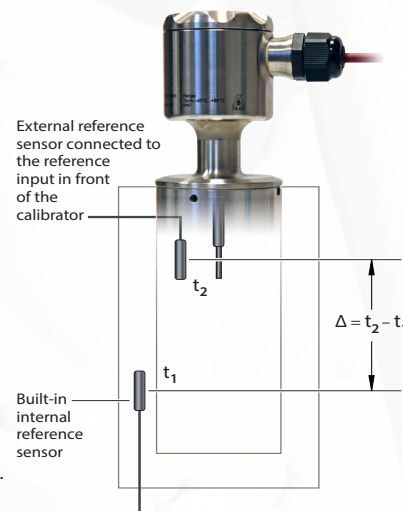

Integrated Support Rod for Secure Sensor Placement

Designed for convenience and ease of use, the optional support rod securely holds sensors in place during calibration, ensuring consistent contact and temperature exposure. Lightweight yet sturdy, the support rod is easy to attach and adjust, providing a stable setup that minimizes measurement errors from sensor movement, even in field conditions.



Direct Reading of Sensor Under Test (Model B Only)

For users who require real-time data from their sensors during calibration, Model B offers direct reading capabilities. This feature allows the calibrator to measure resistance, thermocouple, mA, and voltage directly from the sensor under test, eliminating the need for additional equipment. This capability is essential for applications that require immediate feedback or multi-sensor calibration setups, enhancing flexibility and efficiency.

MVI (Mains Variance Immunity) for Secure Temperature Stability

Unstable power sources are common in industrial settings and can lead to calibration inaccuracies. The RTCt models incorporate MVI technology, which stabilizes power fluctuations by converting the incoming supply to a steady DC voltage, ensuring consistent temperature control and measurement accuracy. This feature enhances the reliability of calibration results in fluctuating environments, such as production lines and on-site testing facilities.

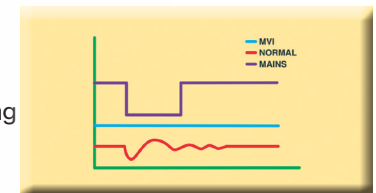

Versatile Predrilled Inserts for Precision Calibration

The RTCt-156 and RTCt-157 calibrators are designed for flexibility, accommodating a wide range of sensor sizes and shapes through an array of predrilled insert options. These inserts simplify calibration by ensuring a snug, stable fit for each sensor, which is essential for achieving accurate, repeatable results across varied applications.

PREDRILLED INSERTS FOR RTCt-156/157

All predrilled inserts have holes for:

4 mm reference sensor • 1/4" reference sensor • 3 mm DLC sensor.

All inserts are supplied with an insulation plug drilled with the necessary holes

Spare part no. for predrilled inserts with reference holes

Sensor diameter	Instrument RTCt-156/157 A/B/C Order code
3 mm	127312
4 mm	127313
5 mm	127314
6 mm	127315
7 mm	127316
8 mm	127317
9 mm	127318
10 mm	127319
11 mm	127320
12 mm	127321
13 mm	127322
14 mm	127323
15 mm	127324
16 mm	127325
Package of the above inserts	127336

Inserts, undrilled incl. insulation plugs

Inserts	Instrument RTCt-156 A/B/C Order code
5-pack, undrilled inserts with no holes	127299
5-pack, undrilled inserts with hole for DLC sensor	127300
5-pack, undrilled inserts with 2 holes for STS reference sensors (4mm & 1/4") and 1 hole for DLC sensor	127301
Undrilled insulation plug	122781

Spare part no. for predrilled inserts with reference holes

Sensor diameter	RTCt-156/157 A/B/C
1/8 in	127302
3/16 in	127303
1/4 in	127304
5/16 in	127305
3/8 in	127306
7/16 in	127307
1/2 in	127308
9/16 in	127309
5/8 in	127310
Package of the above inserts	127335

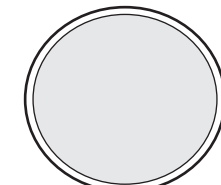
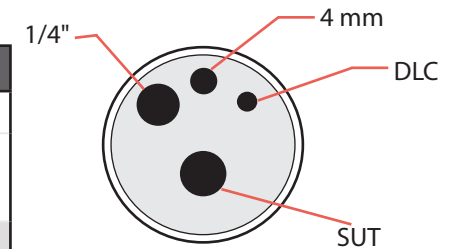

127299

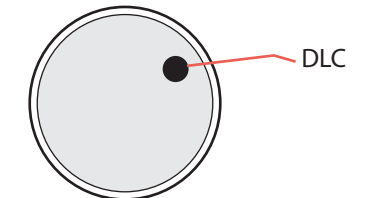

127300

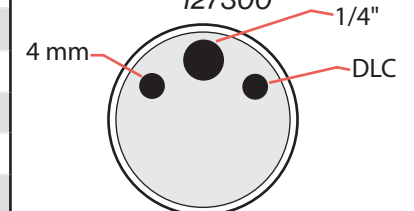

127301

Multi-Hole Inserts for Efficient and Versatile Calibration

The RTCt-156 and RTCt-157 calibrators are designed for adaptability, accommodating various sensor types and configurations through versatile multi-hole insert kits. These high-precision inserts streamline calibration by securely fitting multiple sensors, providing consistent temperature distribution across each sensor for accurate and repeatable results.

MULTI-HOLE INSERTS FOR RTCt-156/157 - METRIC (MM)

All inserts are supplied with an insulation plug drilled with the necessary holes.

Spare part no. for multi-hole inserts - metric (mm)	
Insert type	Instrument
	RTCt-156/157 A/B/C - Order code
Multi-hole type 1	127329
Multi-hole type 2	127330
Multi-hole type 3	127331
Multi-hole type 4	127332
Multi-hole type 7	127241
Multi-hole type 8	127242
Multi-hole type 9	127243
Set of 4 Metric Multi Inserts, 3mm to 16mm (Incl. 127332, 127241, 127242 and 127243)	127326

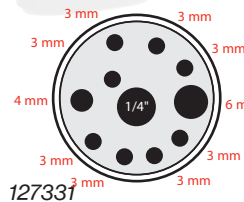
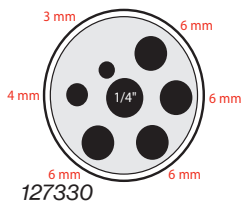
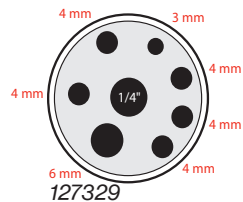
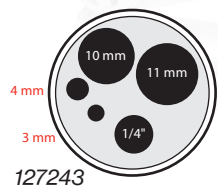
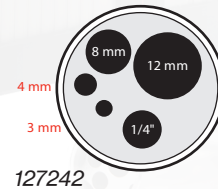
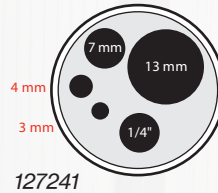
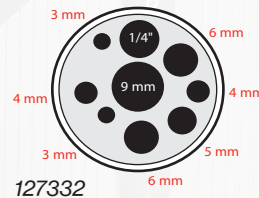

MULTI-HOLE INSERTS FOR RTCt-156/157 - IMPERIAL (INCH)

All inserts are supplied with an insulation plug drilled with the necessary holes.

Spare part no. for multi-hole inserts - imperial (inch)	
Insert type	Instrument
	RTCt-156/157A/B/C Order code
Multi-hole type 5	127327
Multi-hole type 6	127328
Multi-hole type 10	127247
Set of 3 Imperial Multi Inserts, 1/8 to 1/2 inch (Incl. 127308, 127328 and 127247)	127311

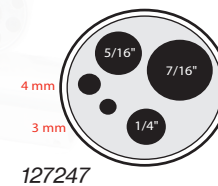
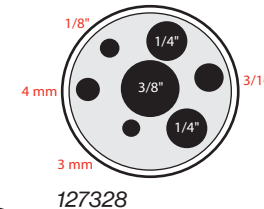
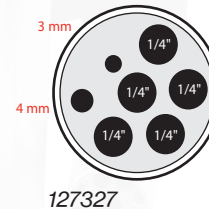

Extended Inserts for Sanitary Sensors	
Insert type	Instrument
	RTCt-156A/B/C Order code
Undrilled Sanitary Sensor Insert RTCt-156	123824
Custom Insert RTCt-156 Sanitary Sensor Insert Drilled According to Customer Supplied Drawing	123868

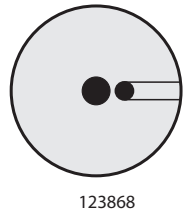
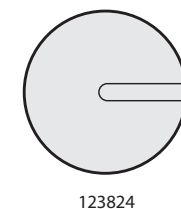

123824

123868

DLC – Dynamic Load Compensation. Making Dry Calibration Accurate and Well Documented

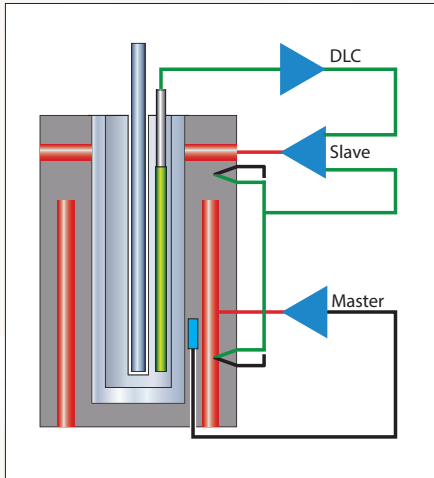

To bring our well documented active dual-zone technology to an even higher level, we have developed the patented DLC system.

This feature makes it possible to perform top calibration specifications without being affected by the actual load, e.g. many sensors or very big sensors.

The DLC sensor improves on the RTCT calibrator's already advanced dual-zone technology by controlling the homogeneity in not only the well, but inside the insert where the sensors-under-test are placed during calibration. The DLC sensor measures the temperature homogeneity in the insert and provides feedback to the active dual-zone system, which compensates the temperature difference to a minimum inside the insert. In this way, the DLC function makes the homogeneity independent of the different loads of the insert, making the RTCT the best performing dry-block calibrator on the market when calibrated and tested according to the globally accepted EURAMET/cg-13 guideline for calibration and testing of dryblocks.

The DLC system is comprised of a special differential temperature sensor designed especially for the RTCT. The sensor is placed in the insert and connected to the calibrator. When the DLC function is enabled, the calibrator will automatically equalize the temperature homogeneity inside the insert, along with the normal temperature control and stabilization. **Note that DLC functionality can not be used when calibrating sanitary sensors.**



DLC – User Advantages

Calibrating with the DLC sensor offers the following advantages:

- 1 Calibration of several sensors simultaneously.
- 2 Calibration of thick sensors.
- 3 Gives TSL (Thermo Sensitive Length) independency. It is no longer necessary to know the TSL of the sensor.
- 4 Compensates for sensor production tolerances like the PT100 element being mounted in various positions in the sensor.
- 5 Trouble free calibration of sensors with PT100 elements up to 60 mm length.
- 6 The DLC indicator proves that the dual-zone is active and functioning well.
- 7 Proves that the calibrator is working perfectly. The DLC value should be very close to 0.00 when the calibrator is loaded with DLC sensor and an external reference sensor.
- 8 Together with the stability indication, the DLC indicates when the calibration values can be read.
- 9 JOFRA's unique, patented DLC system allows RTCT dryblock calibrators to perform with "close-to-laboratory" liquid bath performance.

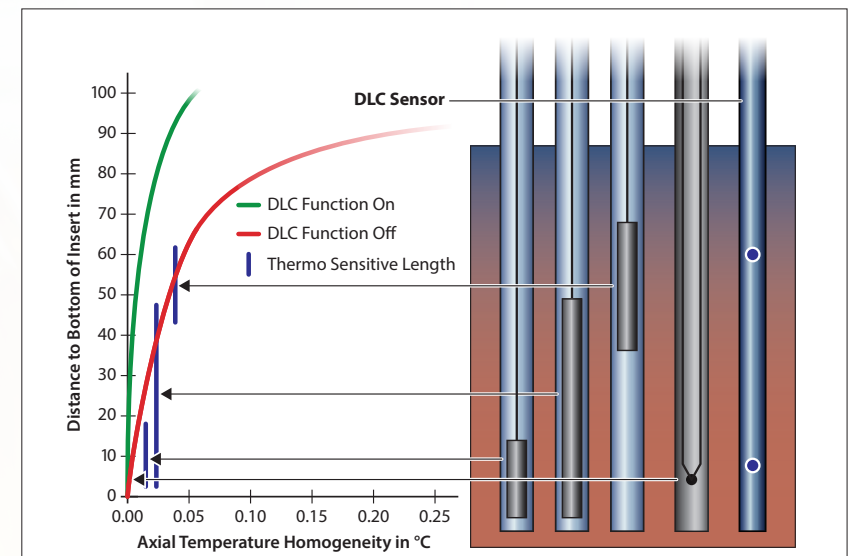

Axial temperature curves for an RTCT calibrator with and without the DLC functionality activated.

High Accuracy Temperature Calibrator

Among the many features of the RTcT Series, one of the most important that our customers depend on is its high accuracy. Through years of innovation and patents, we have continued to solve challenges our customers face when calibrating a wide variety of temperature sensors.

Homogeneous Zones

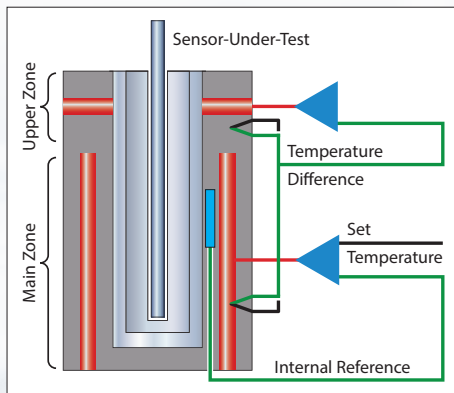

The RTcT series of calibrators provide precision temperature calibration of sensors, whatever the type or format. Our innovative active dual-zone heating technology independently controls each heating zone. This control produces two homogeneous zones, increasing the chances that the sensing element of the sensor-under-test will reach one of these ideal calibration zones. The lower zone ensures optimum heat dissipation throughout the entire calibration zone, while the upper zone compensates for heat loss

from the sensor-under-test and the open top. This design also eliminates the need for extra insulation of sensors-under-test and makes it possible to calibrate liquid-filled and other mechanical sensors.

Application Kit for Calibration of Sanitary Sensors - RTcT-156

The custom-made insert for the RTcT-156 calibrator (models B and C) is specifically designed for sanitary sensor calibration. It allows precise positioning of the sensor while accommodating the reference sensor cable, ensuring accurate and repeatable results.



The STS-102 sanitary application kit provides a complete solution for easy and efficient calibration. It includes:

- ◆ STS-102 sensor
- ◆ Recalibration tube
- ◆ 5-pack of undrilled flange insertion tubes with a cable groove
- ◆ Carrying case, order Number: 127279.

Reference Sensors

We offer reference sensors that communicate directly with the RTcT to automate accurate calibrations for customers looking to provide an even more accurate system.



Our patented DLC system takes the dual-zone heating technology a step further by controlling the homogeneity inside the insert where the sensors-under-test are. The result is a high accuracy calibration, no matter what size or how many sensors are in the insert.



In addition to the DLC, all JOFRA intelligent reference sensors contain the calibration data inside the sensor. Using these sensors removes a source of error as the technician avoids manually entering calibration details. Special 90° sensors and cable-type sensors provide even more flexibility for unique calibration jobs.

Accessories and Supporting Products

We have a line of accessories and supporting products that further enhance the RTCt-156 and RTCt-157 temperature calibrator. These products provide options to pick and choose from depending on your application requirements. We have something to support almost any situation, from items that make calibrating and transporting easier to products that change and document the calibration process.

Important Accessories



Specially Designed Carrying Case

It's more than just a rolling case. Our case includes compartments to store the STS and DLC sensors, the liquid container, inserts, insulation plugs, the support rod set, and tools. Perfect for your portable calibrator. Cat. no. 127292.



Multi-Hole Inserts

We offer two multi-hole inserts to fit almost any sensor diameter without buying numerous inserts. One for metric and one for imperial, our inserts include many sizes and room for reference and DLC sensors. See page 11.



Integrated Support Rod

The integrated support rod helps to mount sensors under test. It is lightweight and mounts on two fixing holes integrated into the RTCt calibrator. Cat. no. 127277.

Supporting Products

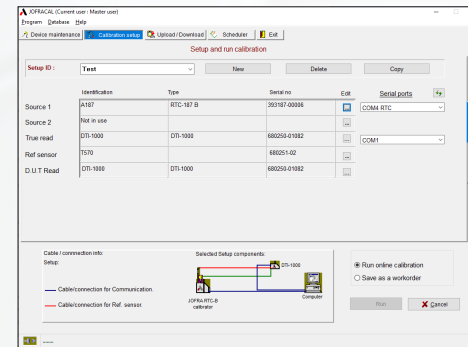

JofraCal Calibration Software

JofraCal is a highly versatile calibration software included with the RTCt calibrators. The software communicates with the RTCt to help ensure easy calibration of all kinds of temperature sensors, such as RTD's, thermocouples, transmitters, and thermoswitches.

JofraCal has a manual set-up that accepts user-entered data or an automatic mode that allows the RTCt to operate as a

stand-alone instrument with work orders. The software stores all completed calibration information on the computer for easy retrieval and certificate printing.

For more information and details, [visit our JofraCal website here](#).

JOFRA ASM Scanner

Using the JOFRA RTCt series together with the ASM, Advanced Signal Multi-scanner, offers a great time-saving automatic solution to calibrate multiple temperature sensors at the same time. The ASM series is an eight-channel scanner controlled by the JofraCal software on a PC. Up to 3 ASM units can be stacked to calibrate up to 24 sensors at a time. It can handle signals from 2-, 3- and 4 wire RTD's, thermocouples, transmitters, temperature switches, and voltage.



Specifications

Functional Specifications

Unless noted, specifications apply to both RTcT-156 and RTcT-157

Temperature Range

RTcT-156

@ ambient temp. 0°C/32°F..... **-46 to 155°C/-51 to 311°F**

@ ambient temp. 23°C/73°F **-32 to 155°C/-26 to 311°F**

@ ambient temp. 40°C/104°F **-17 to 155°C/1.4 to 311°F**

RTcT-157

@ ambient temp. 0°C/32°F..... **-57 to 155°C/-71 to 311°F**

@ ambient temp. 23°C/73°F **-45 to 155°C/-49 to 311°F**

@ ambient temp. 40°C/104°F **-31 to 155°C/-24 to 311°F**

Accuracy with External STS Ref. Sensor (models B and C)

RTcT-156 (model B and C)..... ***±0.040°C/±0.072°F**

RTcT-156 (model B and C)..... ****±0.060°C/±0.108°F**

RTcT-157 (model B and C)..... ***±0.040°C/±0.072°F**

RTcT-157 (model B and C)..... ****±0.065°C/±0.117°F**

*12-month period. Relative to reference standard. Specifications by use of the external JOFRA STS-200 reference sensor.

** Total system accuracy, 12 months, incl. STS sensor and calibration uncertainty with accredited system calibration (RTcT-157 calibrator with STS 200 Reference sensor / ISO/EN/IEC 17025)

Accuracy with Internal Ref. Sensor (models A, B, and C)

±0.10°C/±0.18°F (RTcT156), ±0.11°C/±0.2°F (RTcT-157)

The RTcT Series follows rigorous metrological principles, ensuring that accuracy is reliable, repeatable, and fully traceable under documented conditions.

Stability

±0.005°C/±0.009°F

Measured after the stability indicator has been on for 15 minutes.

Measuring time is 30 minutes

Resolution (user selectable)

All Temperatures..... **1° or 0.1° or 0.01° or 0.001°**

Temperature Unit in Display

User Selectable **°C, °F, or K**

Radial Homogeneity (difference between holes)

0.01°C/0.02°F at -32 °C/26 °F

Heating Time

RTcT-156

-32 to -23°C/-22 to 73°F..... **4 minutes**

23 to 155°C/73 to 311°F..... **15 minutes**

RTcT-157

-45 to 23°C/ -49 to 73°F..... **7 minutes**

23 to 155°C/73 to 311°F..... **17 minutes**

Cooling Time

RTcT-156

155 to 100°C/311 to 212°F..... **4 minutes**

100 to 23°C/212 to 73°F..... **8 minutes**

23 to -24°C/73 to -11°F..... **14 minutes**

-24 to -32°C/ -11 to -26°F..... **10 minutes**

155 to -32°C/311 to -26°F..... **36 minutes**

RTcT-157

155 to 100°C/311 to 212°F..... **5 minutes**

100 to 23°C/212 to 73°F..... **10 minutes**

23 to -30°C/73 to -22°F..... **17 minutes**

-30 to -45°C/ -22 to -49°F..... **20 minutes**

155 to -45°C/311 to -49°F..... **52 minutes**

Time to Stability (approx.)

10 minutes

Physical Specifications

Weight and Instrument Size (LxWxH)

Weight..... **10.3 kg /22.7 lb**

(LxWxH) **362 x 171 x 363 mm /14.3 x 6.7 x 14.3 in**

Shipping (without carrying case/ In cardboard case)

Weight..... **14.8 kg /32.6 lb**

(LxWxH) **580 x 250 x 500 mm /22.8 x 9.8x 19.7 in**

Shipping (including optional carrying case)

Weight..... **20.5 kg /45.1 lb**

(LxWxH) **650 x 440 x 610 mm /25.6 x 17.3 x 24 in**

Shipping (carrying case only)

Weight..... **12.2 kg /27 lb**

(LxWxH) **650 x 440 x 610 mm /25.6 x 17.3 x 24 in**

Immersion Depth

160 mm/6.3 in

Input Specifications

All input specifications apply to the dry-block of the calibrator running at the respective temperature (stable plus an additional 20 minute period).

All input specifications are valid for the RTcT-168.

RTD Reference Input (models B and C)

Type..... **4-wire RTD with true ohm measurements (1)**

F.S. (Full Scale)..... **400 ohm**

Accuracy (12 months)..... **±(0.0012% rdg. + 0.0005% F.S.)**

RTD Type	Temperature		12 Months	
	°C	°F	°C	°F
Pt100(90)385 Reference	-50	-58	± 0.015	± 0.026
	0	32	± 0.016	± 0.028
	155	311	± 0.020	± 0.035

(1) True ohm measurement is an effective method to eliminate errors from induced thermoelectrical voltage.

DLC Sensor Input (models B and C)

TC diff	Temperature		12 Months	
	°C	°F	°C	°F
DLC-155	-50	-58	± 0.015	± 0.024
	0	32	± 0.012	± 0.020
	155	311	± 0.010	± 0.016

Specifications

RTD Sensor Under Test Input (model B)

F.S. (range) **400 ohm**
Accuracy (12 months)..... **±(0.002% Rdg.+0.001% F.S.)**
F.S. (range) **4000 ohm**
Accuracy (12 months)..... **±(0.003% Rdg. + 0.003% F.S.)**
2-wire..... **add 50 mOhm**

RTD Type	Temperature		12 Months	
	°C	°F	°C	°F
Pt100(90)385	-50	-58	± 0.015	± 0.026
	0	32	± 0.016	± 0.028
	155	311	± 0.020	± 0.035
Pt500(90)385	-50	-58	± 0.067	± 0.120
	0	32	± 0.070	± 0.125
	155	311	± 0.078	± 0.139
Pt1000(90)385	-50	-58	± 0.037	± 0.066
	0	32	± 0.039	± 0.070
	155	311	± 0.045	± 0.081

Thermocouple Input

Range **-10mV to 78 mV**
F.S. (Full Scale)..... **78 mV**
Accuracy (12 months) **±(0.005% Rdg. + 0.005% F.S.)**

TC Type	Temperature		12 Months*	
	°C	°F	°C	°F
E	-50	-58	± 0.08	± 0.14
	0	32	± 0.07	± 0.12
	155	311	± 0.07	± 0.12
J	-50	-58	± 0.09	± 0.16
	0	32	± 0.08	± 0.14
	155	311	± 0.08	± 0.15
K	-50	-58	± 0.12	± 0.21
	0	32	± 0.10	± 0.18
	155	311	± 0.11	± 0.19

T	-50	-58	± 0.12	± 0.22
	0	32	± 0.11	± 0.19
	155	311	± 0.09	± 0.16
R	-50	-58	± 1.06	± 1.91
	0	32	± 0.74	± 1.33
	155	311	± 0.48	± 0.86
S	-50	-58	± 0.98	± 1.77
	0	32	± 0.73	± 1.31
	155	311	± 0.50	± 0.89
N	-50	-58	± 0.17	± 0.30
	0	32	± 0.16	± 0.28
	155	311	± 0.14	± 0.24

* Excludes CJC accuracy ± 0.3° C / ± 0.54° F.

Transmitter Supply

Output Voltage **24VDC ±10%**
Output Current **Maximum 28 mA**

Transmitter Input mA (model B)

Range **0 to 24 mA**
Accuracy (12 months)..... **±(0.005% Rdg. +0.010% F.S.)**

Voltage Input VDC (model B)

Range **0 to 12 VDC**
Accuracy (12 months)..... **±(0.005% Rdg. +0.010% F.S.)**

Switch Input (model B)

Switch Dry Contacts

Test Voltage..... **Maximum 2,5 VDC**
Test Current..... **Maximum 0,7 mA**

Mains Specifications

Voltage **115V (90-127) / 230V (180-254)**
Frequency, non US Deliveries **50/60 Hz (47-63 Hz)**
Frequency, US Deliveries **60 Hz (57-63 Hz)**
Power Consumption (max.) **350VA**

Communications Interface

Serial Data Interface..... **USB 2.0 Device Port**
Serial Data Interface..... **USB 2.0 Host Port (3x)***
LAN..... **Ethernet MAC 10/100 Base-T***

Miscellaneous

Operating Ambient Temperature..... **0 to 40°C / 32 to 104°F**
Storage Temperature..... **-20 to 50°C / -4 to 122°F**
Humidity **0 to 90% RH**
Protection Class..... **IP-10**

Inserts

All inserts are supplied with a matching insulation plug, except for custom designed Sanitary Sensor inserts.

Insert Dimensions (Standard Insert)

Outer Diameter **29.7 mm / 1.17 in**
Inner Diameter (multi hole) **25.6 mm / 1.01 in**
Outer Diameter (single hole) **22.0 mm / 0.877 in**
Length..... **150 mm / 5.91 in**

Weight of Non-Drilled Insert (approx.)

290 g / 10.2 oz

Options & Accessories

Standard Delivery

Models A, B, and C Include:

- RTCT dry-block calibrator (user specified)
- Mains power cable (user specified)
- Wi-Fi Dongle
- Accredited certificate - temperature performance
- Tool for insertion tubes
- JOFRACAL
- USB cable
- Set of rubber cones for insulation plugs
- Manual

Model B Instruments Also Include:

- Test cables (2 x red / 2 x black, with test clips)
- Accredited certificate - input performance for reference sensor and DLC sensor
- Accredited certificate - input performance for sensor-under-test inputs

Model C Instruments Also Include:

- Accredited certificate - input performance for reference sensor and DLC sensor

Accessories

Wi-Fi Dongle (Included as standard), see page 4	130817
Extra fixture for sensor grip	125066
Extra sensor grip	125067
Thermocouple Male Plug – Type J – Black	120516
Thermocouple Male Plug – Type K – Yellow	120517
Thermocouple Male Plug – Type N – Orange	120514
Thermocouple Male Plug – Type T – Blue	120515
Thermocouple Male Plug – Type R / S – Green	120518
Thermocouple Male Plug – Type Cu-Cu – White	120519
Carrying Case with Trolley, see page 15	127292

Functional Comparison



Model A
RTCT-A reference temperature calibrator.



Model B
RTCT-B reference temperature calibrator with input for reference sensor, DLC sensor, and two sensors-under-test.



Model C
RTCT-C reference temperature calibrator with input for reference sensor and DLC sensor.



Models	Model A	Model B	Model C
Dual-zone heating/cooling block	■	■	■
MVI – Mains Variance Immunity (or similar)	■	■	■
Stability indicator	■	■	■
Automatic step function	■	■	■
USB communication	■	■	■
Display resolution 0.001°	■	■	■
Programmable max. temperature	■	■	■
Calibration of short sensors in special insert	■	■	■
External precision reference sensor input		■	■
External precision DLC reference sensor input		■	■
“SET” follows “TRUE”		■	■
Load compensation functionality		■	■
Input for RTD, TC, V, mA		■	
4-20 mA transmitter input incl. 24 VDC supply		■	
All inputs scalable to temperature		■	
Automatic switch test (open, close, and hysteresis)		■	
Download of calibration work orders from PC	■	■	■
Upload of calibration results (as found & as left)	■	■	■

Ordering Information

Sample Order Number

RTCt156B230ASMMDLGR2EACT

JOFRA RTCt-156 B with 230VAC, EU power cord, no insert (to be ordered separately, DLC, 4 mm diameter STS-200 reference sensor, full EA temperature calibration certificate, and carrying case with trolley.

Base Model Number	
RTCt156	RTCt-156 series, -32 to 155°C (-22 to 311°F)
RTCt157	RTCt-157 series, -45 to 155°C (-49 to 311°F)
Model Version	
A	Basic model, without input
B	Full model, incl. DLC sensor input, Reference sensor input, Sensor-under-test input
C	Middle model, incl. DLC sensor input, Reference sensor input
Power Supply (US deliveries 60 Hz only)	
115	115 VAC
230	230 VAC
Mains Power Cable	
A	European, 230 V
B	USA/Canada, 115 V
C	UK, 240 V
D	South Africa, 220 V
E	Italy, 220 V
F	Australia, 240 V
G	Denmark, 230 V
H	Switzerland, 220 V
I	Israel, 230 V
Insert Type and Size	
NON	NON, The inserts must be ordered separately (Page 11 and 12)
Dynamic Load Compensation (B and C models only—optional)	
DLC	DLC sensor
STS Reference Sensor (B and C models only—optional)	
R1	STS-102 Ref. sensor. Dia. 4 mm. Length 30 mm (STS102A030EH)
R2	STS-200 Ref. sensor. Dia. 4 mm. Length 179 mm (STS200A915EH)
R3	STS-200 Ref. sensor. Dia. 1/4" mm. Length 179 mm (STS200B915EH)
Calibration Certificate	
H	Accredited Certificate — ISO17025
EA	Full EURAMET Accredited Certificate — ISO17025
HS	System Calibration — Accredited Certificate — ISO17025 (B & C model only)
EAS	System Calibration — Full EURAMET Accredited Certificate — ISO17025 (B & C model only)
EASD	System Calibration — Full EURAMET Accredited Certificate with DLC — ISO17025 (B & C model only)
Base Model Number	
CT ..	Solid Protective Carrying case with trolley
SR ..	Support rod set
TR ..	Solid Protective Carrying case with trolley & Support rod set

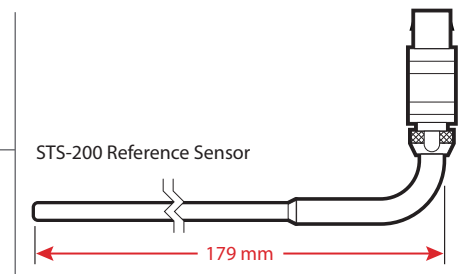

RTCt156 B 230 A NON DLC R2 EA CT

USA, Florida
Tel +1 (800) 527 9999
cal.info@ametek.com

USA, California*
Tel +1 (800) 444 1850
crystal@ametek.com

India
Tel +91 22 2836 4750
jofra@ametek.com

Singapore
Tel +65 6484 2388
jofra@ametek.com

China, Shanghai
Tel +86 21 5868 5111
jofra.sales@ametek.com.cn

China, Beijing
Tel +86 10 8526 2111
jofra.sales@ametek.com.cn

United Kingdom
Tel +44 (0) 1243 833 302
caluk.sales@ametek.com

France
Tel +33 (0) 30 68 89 40
general.lloyd-instruments@ametek.fr

Germany
Tel +49 (0) 2159 9136 510
info.mct-de@ametek.de

Denmark*
Tel +45 4816 8000
jofra@ametek.com

ametekcalibration.com

No part of this document may be reproduced or modified in any form or by any means, electronic or mechanical, without express written permission from JOFRA.
©2023 AMETEK Incorporated

