

LMG610

Precision Power Analyzer with  Dual Path



The Most Precise in its Class

As Compact Desktop Device with Touch Screen

LMG610 – powerful, convenient, flexible



Features	Harmonics	<ul style="list-style-type: none"> • Harmonics and interharmonics up to 2000th order, in compliance with EN61000-4-7
	Script Editor	<ul style="list-style-type: none"> • Flexible scripting tool for special applications • Convenient calculation of all derived variables in the power analyzer
	Simultaneity	<ul style="list-style-type: none"> • Simultaneous measurement of I, V and P-variables and harmonics • Presentation in tabular or graphical form
	Flexible Filters	<ul style="list-style-type: none"> • Signal filters freely configurable by frequency, type and characteristics
	Plug 'n' Measure	<ul style="list-style-type: none"> • Connected current transducers are automatically configured and supplied with power • Convenient commissioning with zero risk of misconfiguration
	Synchronization	<ul style="list-style-type: none"> • Synchronize on different frequency sources
	Flicker	<ul style="list-style-type: none"> • Interactions between grid and loads according to EN61000-4-15
	Sample Values	<ul style="list-style-type: none"> • Direct access to high-resolution sample values and harmonics via interfaces
	Event Triggering	<ul style="list-style-type: none"> • Event based recording of sample values
GUI	Smart Vision	<ul style="list-style-type: none"> • Smart add-on functions for convenient evaluation of measurements
	Touch screen	<ul style="list-style-type: none"> • Large 800x480 display • Flat operating hierachy for rapid access to all important menu items
	Remote control	<ul style="list-style-type: none"> • Real-time display of all device functions, remote operation and data visualization • No rethinking required, thanks to the new unified GUI
Storage & Periphery	CAN bus	<ul style="list-style-type: none"> • Simple provision of measured values via CAN bus
	Memory	<ul style="list-style-type: none"> • Internal storage even of long-term measurements with the shortest cycle time, thanks to high-capacity mass-storage device
	Interfaces	<ul style="list-style-type: none"> • Excellent connectivity provided by USB 2.0, Gigabit Ethernet and RS232

Setting the bar in power analysis

For more than three decades, ZES ZIMMER has been focused solely on high-precision power measurement technology – so we know there is more to it than simply measuring current and voltage. Anyone who has tried to use generic systems for power measurement will have rapidly run up against their limits. What’s the situation

with common-mode rejection? Is the measurement result still reliable for power factors in the range of 0.01? Is the earth capacitance low enough to avoid interference by leakage currents? In what frequency ranges does the manufacturer guarantee the stated measuring accuracy? It quickly becomes clear that only a device designed

specifically for power measurement can really satisfy these ambitious requirements. The ZES ZIMMER LMG610 stands out in the market for its extreme reliability, best-in-class accuracy, and maximum frequency range – the ideal prerequisites for excellent results.

LMG90



LMG95



LMG610



1985 *The first digital power analyzer*

1997 *Highest precision*

2016 *Modern operation & DualPath*

Measurement Channels

DualPath

- Narrowband-, wideband RMS values and harmonics in a single measurement, simultaneously and free of aliasing

Sampling Rate

- High sampling rate of up to 1.2 MS/s

Resolution

- Calculation of RMS values with a minimum cycle time of 30 ms

Accuracy

- Extremely high measurement accuracy of 0.015 % of the measured value + 0.01 % of the measuring range limit

Dynamic Range

- Full dynamic range continuously available from 500 μ A to 32 A and 3 mV to 1000 V
- Power measurement from standby to full load (max. 32 A) possible without mechanical changes

Bandwidth

- Analog frequency range from DC up to 10 MHz
- Analysis of 400 harmonics in the GUI and 2000 via interface

Continuity

- Gapless sampling at 18 bit A/D converter resolution and a cycle time of 30 ms
- No discontinuities in recorded measurements and complete capturing of all relevant events

U-I-Synchronicity

- Time offset between current and voltage input adjustable in steps < 3 ns
- Very precise measurements at small power factors (λ) and/or high frequencies

Immunity

- Reliable even in areas with difficult electromagnetic conditions

3 Types

- The right analyzer for any task

LMG610-A1: 0.025 % accuracy, up to 10 MHz
 LMG610-B1: 0.07 % accuracy, up to 500 kHz
 LMG610-C1: 0.04 % accuracy, up to 10 kHz

Ground Capacitance

- Particularly low earth capacitance of < 90 λ avoids interference by leakage currents

Misc.

Calibration

- 12-month calibration interval guarantees low maintenance costs and optimum device availability
- Includes calibration certificate upon delivery, free of charge

Warranty

- 24 months warranty

The adequate combination of bandwidth, accuracy and costs for every application

Power analyzers are available in different accuracy classes to allow the user to choose the right tool for the job at hand. After all, not all applications require maximum precision; often lower resolutions and frequency ranges are sufficient. Unfortunately, not all measuring applications observe this dis-

tinction. It is entirely possible, for instance, to have need of different frequency ranges and accuracy levels at different points in the same measurement configuration. This is why the LMG610 is offered in three different types, which ensures that you always have a measuring device tailored to

your needs for your particular application, without having to accept trade-offs in accuracy or take a sledgehammer to crack a nut, if a lower price solution could have served your purposes equally well.

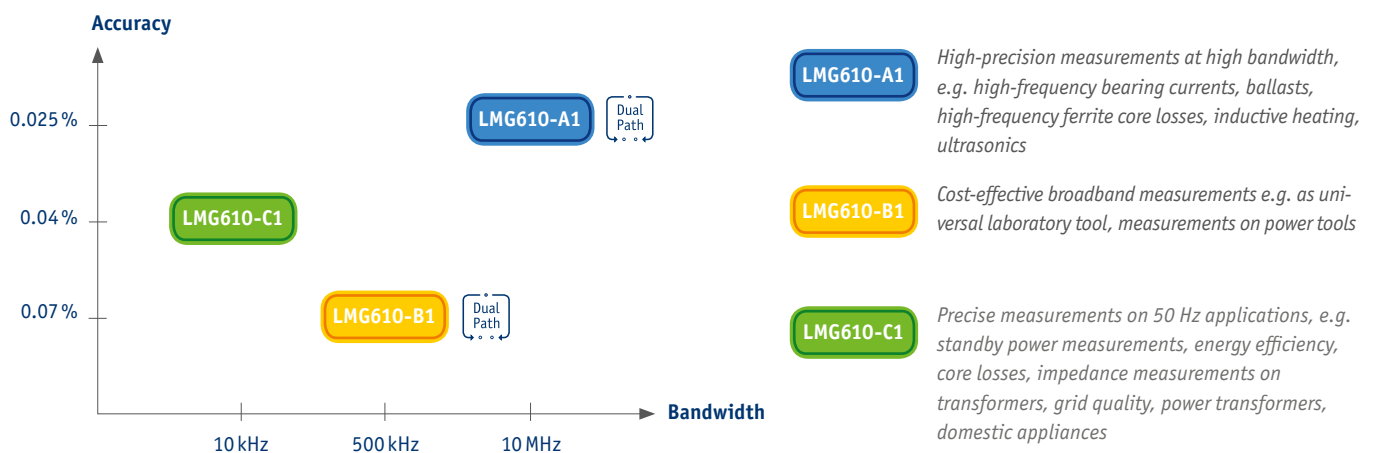

Gapless (=zero blind) measurement

In the course of stricter monitoring of the consumption and efficiency of electrical devices, new standards and procedures are continuously being published (e.g. SPECpower_ssj2008, DIN EN 50564), in order to enable an objective comparison of products from different manufacturers. Be it an office computer, server or household appliance, the same principle applies: the procedure always requires long

term analysis of the power consumption, taking into account all of the relevant operating conditions. The differences here between minimum load - e.g. in standby - and full load can be of a significant magnitude, which makes precise measurement very challenging (see also application report no. 112 „Measurement of standby power and energy efficiency“ on www.zes.com). Some of the

measurements required must be performed over several hours, still with no gaps. By selecting a sufficiently wide measurement range, changing ranges and the inevitably associated losses in data can be avoided. Here the high basic accuracy of the LMG610 ensures precise measurement results, even at the lower limit of a range.

Measuring in two bandwidths at the same time, thanks to DualPath - no compromises, no doubts

On conventional power analyzers, a signal first undergoes analog conditioning, followed by optional anti-aliasing filters, to then be fed into an A/D converter. The resulting signal can afterwards be used for the calculation of cycle-based RMS values. Alternatively it can serve as the base for an FFT or further digital filtering. Due to the limitation to a single A/D converter, there are inherently some downsides to be factored

in with conventional devices. If measurements are carried out with filters active, in order to avoid aliasing with FFTs, then the wide-band values are lost. With the filters switched off, strictly speaking, FFTs should not be used. If, in spite of this, FFTs are used without an anti-aliasing filter for measurements across the full frequency range, then the quality of the calculated values is questionable. An aliasing error of 50%, for

instance, is easily detected, however a deviation of 0.5% could go unnoticed. Ultimately, when you alternate filtered and non-filtered measurements, the validity of the results is equally in question, as this involves the assumption that the signal does not change over time, which is in practice hardly ever the case. In addition, this procedure is especially time consuming.

LMG610



- ✓ Fast results
- ✓ Complete broadband values
- ✓ Correct FFT
- ✓ Precise results

Conventional analyzers

- ✗ Aliasing risk
- ✗ Loss of broadband values
- ✗ Waiving of FFT
- ✗ Suspicious staggered values
- ✗ Lengthy measurements



In the end, the above makes all of the measurement methods presented an unsatisfactory compromise. This is why ZES ZIMMER has fundamentally redesigned signal processing and developed the DualPath architecture. The analog side is the same as in conventional measuring devices, however the subsequent digital processing has been revolutionized. The LMG610 is the first power analyzer to have two A/D converters in two independent signal paths; One, for the filterless measurement of the wide-band signal, and another, for the narrow-band signal at the output of the anti-aliasing filter. The parallel processing of the digitized sample values gives the user access to both measurements of the same signal, without risking aliasing effects. This unique procedure avoids all of the downsides of previous approaches and guarantees the most precise result in the shortest time possible.

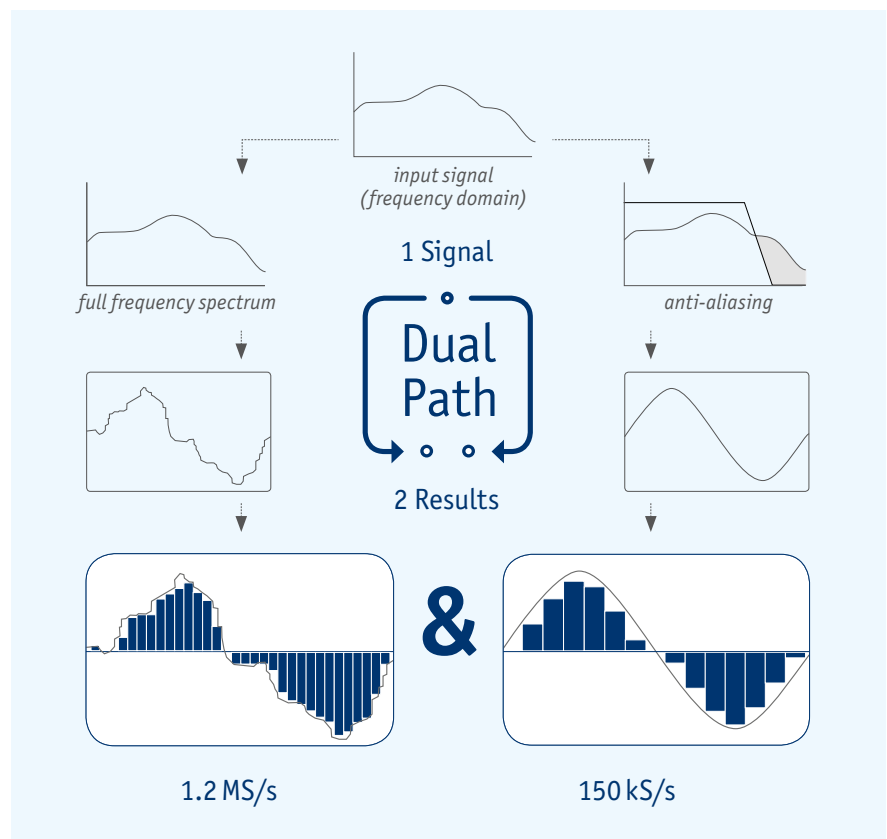

Precise measurements thanks to optimal alignment

Accurate power measurement requires a highly fine-tuned alignment of current and voltage channels. This is where the LMG600 series is setting a new global standard with timing differences of <3 ns. When measuring at 50 Hz, this offset corresponds to a phase error <1 μ rad or 0.2". The analysis of many applications only becomes possible by this precise adjustment. For precise loss measurements of transformers, inductors, capacitors, and ultrasonic sensors, a minimum offset is essential, because it is in particular at low power factors and therefore

poor utilization of measuring ranges, that even a small offset can produce errors in the magnitude of single-digit percentages. At high frequencies and thus very short periods the phase shifts between current and voltage have dramatic effects on active and apparent power. The LMG610 handles even these extreme applications without additional options or adjustments. The instrument fully complies with these measuring tasks in its standard out-of-the-box configuration. The specified accuracies do not only apply to power factor $\lambda = 1$, but to all values

$0 < \lambda < 1$. Even standby measurements and gas discharge lamps, which are still used in video projectors, pose no challenge for the LMG610 due to its excellent specifications. The LMG610 is the universal measurement instrument for every power electronics engineer. Thanks to its high accuracy, it is even suitable for calibration and validation tests.

Easy to use – with or without touchscreen

To ensure that the LMG610 can be used in all conditions, particular attention has been paid to universal operability. All display modes and setting options can be operated both with the touchscreen or the keypad, without exception. The optimized design consistently produces a direct reference between the keypad and the associated views and setting options on the screen. To use the device effectively requires practically no familiarization. The graphical user interface directs the user precisely to the required results, without detours. Be it effective values for

voltage or current, associated harmonics or cumulative values, they are only a single press of a button away. In addition, user-defined views allow to group together measured values of one's choice, so that all the parameters that are important are always available at a glance. This ergonomic means of operation and the associated time savings contribute directly to the productive use of the LMG610. The eight context-specific double softkeys to the right of the display, whose function always corresponds to their on-screen counterparts on the right-hand side

of the screen, are especially important for ease-of-use. One can determine the function assigned to a given softkey at a glance. The double softkey design enables the respective parameter to be rapidly configurable; switching through views that are not relevant is no longer necessary. Should there be questions as to function and control while operating the device, the relevant sections of the manual can be displayed at any time.

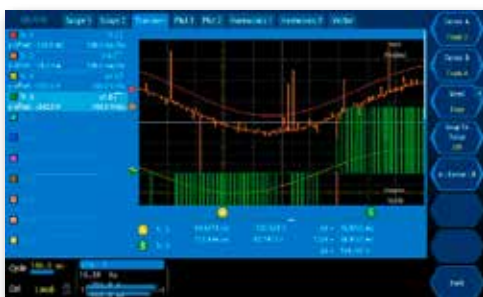

Simultaneous measurement of narrow and broadband values



Superimposed help text from manual



Display of measured RMS values



Display of harmonic values

Exact measurements without limits

Although the LMG610 offers unmatched dynamic range, both in the voltage and the current area, there are always applications with extraordinary requirements in terms of measurement ranges. Whether you are dealing with currents of several hundred amps or voltages of several kilovolts, ZES ZIMMER has the right solution at the ready. We offer a wide range of current and voltage sensors, which work perfectly in unison with the LMG610 precision power analyzer and extend the measurement ranges of the device by the required degree. The sensors of our Plug 'n' Measure series are equipped with a bus system, which enables automatic

configuration of the LMG610. This allows for all of the important parameters, such as the precise scaling factor, the delay compensation variable, the last calibration date, and the sensor type, to be read automatically by the power analyzer and taken into account during measurements. Moreover, the sensors are actively supplied with power by the LMG610, so that a separate power supply is no longer required. With Plug 'n' Measure there is no need for fine adjustment by the user and it allows to obtain the best possible measurement results. From the user's perspective, it is not possible to distinguish any difference between direct and sensor-sup-

ported measurement. Of course, other commercially available sensors can also be used together with the LMG610.



Sensor type PCT

Everything important just a click away

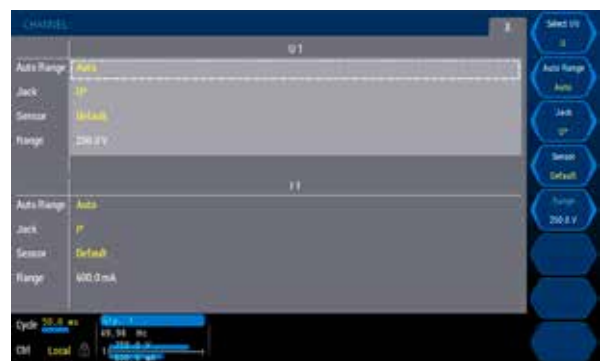
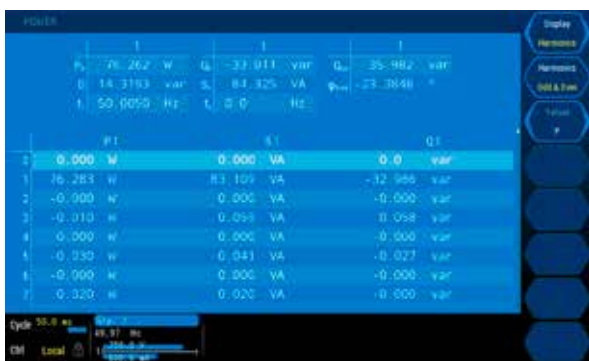

Click on the level indicator: configuration of channel specific measurement ranges and sensor settings



Click on Cycle: Configuration of cycle time or reference

Click on softkey <Display>: toggling between RMS values and harmonics

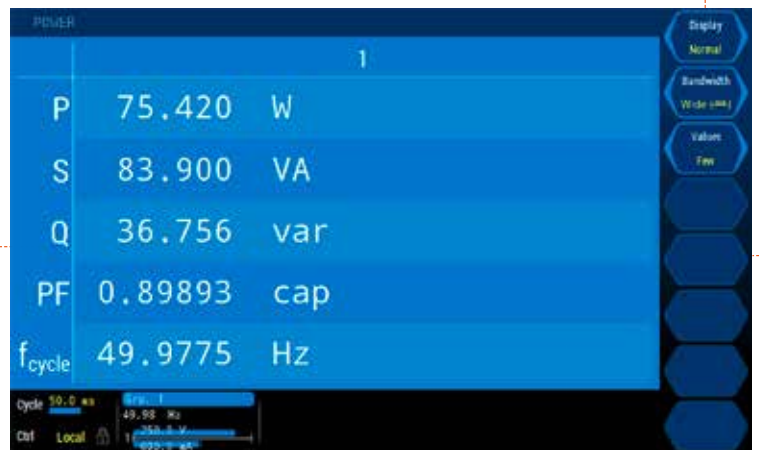

Click on the group: configuration of activation, synchronization, filters, etc.

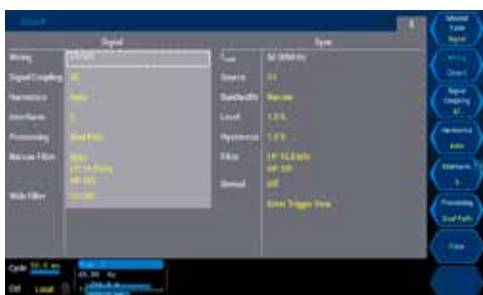

Switched-mode power supplies

Advances in power electronics have already caused the relatively large and heavy transformer power supplies of the past to be predominately replaced years ago by smaller, lighter and more efficient switched-mode power supplies. Today they can be found in practically all electrical devices connected to the power grid. While they avoid many of

the downsides of their predecessors, they also bring new challenges: for one, the circuit feedback due to harmonics is not insignificant and must be limited by standards (EN61000-3-2, EN61000-3-12). Secondly the high switching frequencies of up to several hundred kilohertz can lead to problems with electromagnetic compatibility, both on the

grid side and on the consumers' part. The role of power measurement technology is to support the manufacturer in optimizing their products.

CHALLENGES	LMG610
<ul style="list-style-type: none">• Gapless, standards-compliant measurement of harmonics• High frequency range for analysis of conditions at pulse frequencies >300 kHz• Quick and gapless sampling for measuring steep switching flanks• Reliable measurement even at power factors $\lambda < 0.01$	High Bandwidth
	Continuity
	Flexible Filters
	High Sampling Rate
	U-I-Synchronicity
	Harmonics

Solid & laminated magnetic cores

Under the influence of changing fields both due to continuous remagnetization and eddy currents, the ferromagnetic components of an electrical machine are subject to losses, which are ultimately converted into heat or vibrations. The total losses are frequency-dependent and should be minimized as far as possible, as they have a significant effect

(for example) on the range of the batteries in electric vehicles. The core power loss is directly produced by the excitation current of a test winding and the magnetization voltage of a sensor winding. The magnetic flux density in the core material can be derived from the rectified value of the voltage induced in the sensor winding. The magnetic field strength is

proportional to the current flowing in the test winding. While the high-frequency currents can be measured directly in magnetic cores, high-accuracy measuring transducers are used for high amp values of laminated sheet packages.

CHALLENGES	LMG610
<ul style="list-style-type: none">• Precise determination of the active power, even at lowest power factors ($\lambda < 0.01$) and very low voltages• Calculation of a multitude of derived variables such as peak value of field strength (H_{pk}), magnetic flux density (B_{pk}), and amplitude permeability (μ_a)• Convenient integration of transducers for high currents	High Bandwidth
	Accuracy
	Script Editor
	Plug 'n' Measure
	U-I-Synchronicity

Conformance testing for the aerospace industry

Particularly in the aerospace industry, electromagnetic compatibility between installed systems poses an existential threat. For this reason, applicable legislation such as ABD0100.1.8 sets limits on harmonic cur-

rents up to the range of 150 kHz. These harmonics can be analyzed using the LMG610. First of all, this is possible directly thanks to the implementation of harmonics analysis, and secondly it allows for the desired level

of detail through the transfer and analysis of the sampling values using external software.

to be continued on top of following page 

CHALLENGES

- High accuracy even at high frequencies
- Aliasing-free harmonic analysis up to 150 kHz
- Powerful FFT with up to 2,000 harmonic components

LMG610

High Bandwidth

Accuracy

Harmonics

High Sampling Rate

Lighting technology

In an effort to reduce energy consumption, light bulbs are being replaced all around the world with ever more efficient lighting sources. While on the consumer end all it requires is to insert a new product into the existing fitting, the differences on the electrical level are considerable – in contrast to conventional bulbs, LED lights and compact flu-

orescent lights („low-energy light-bulbs“) are controlled by special electronic chokes. Some of these chokes work with switching frequencies of up to 200 kHz and produce signal distortions at frequencies of up to 1 MHz. The manufacturers are required first and foremost to prevent damaging circuit feedback, and second, to ensure optimum

service life for their products. To achieve the aforementioned objective, a controlled warm start is often performed. It must then be ensured that this was done properly, by making appropriate measurements.

CHALLENGES

- Broad frequency range of the measurement, hand-in-hand with a high level of precision
- Verification of standby power of ballasts even for $\lambda < 0.01$
- Minimal earth capacitance to avoid leakage currents during the measurement

LMG610

High Bandwidth

Accuracy

Flexible Filters

Ground Capacitance

U-I-Synchronicity

CE compliance testing for harmonics and flicker

Electrical equipment, systems and devices must satisfy the Directives and Ordinances of the EU on the permitted level of electromagnetic emissions and immunity to electromagnetic effects, if they are put on the market inside the European Union (EU). Two different types of grid emissions are tested: harmonics and flicker. Any electrical device with a non-linear load characteristic produces current harmonics. Thanks to the

impedance of the grid, these cause drops in voltage and resulting distortions. In addition, certain devices (e.g. instantaneous water heaters, heating furnaces, et cetera) control their power consumption by abruptly switching on and off, which destabilizes the voltage level thanks to the grid impedance. This produces fluctuations in voltage, which trigger variations in brightness in the electric lighting („flicker“). In combination

with a suitable AC source and reference impedance, the LMG610 is the tool of choice for the qualified assessment of harmonics and flicker. LMG Test Suite (see Accessories) is providing a user-friendly software solution for this, which turns performing conformity tests for electromagnetic compatibility into child's play.

CHALLENGES

- Verification of absence of distortions and voltage stability of the source
- Measurement of signals at significantly different levels
- Clearly organized management of a multitude of measured values

LMG610

LMG610-C1

Accuracy

Harmonics

Flicker

Dynamic Range

Test Suite

Technical data (summary), valid for $0 \leq \lambda \leq 1$

LMG610-A1 Accuracy	± (% of measured value + % of maximum peak value)									
	DC	0.05 Hz ... 45 Hz 65 Hz ... 3 kHz	45 Hz ... 65 Hz	3 kHz ... 10 kHz	10 kHz ... 50 kHz	50 kHz ... 100 kHz	100 kHz ... 500 kHz	500 kHz ... 1 MHz	1 MHz ... 2 MHz	2 MHz ... 10 MHz
Voltage U*	0.02+0.08	0.015+0.03	0.01+0.02	0.03+0.06	0.2+0.4		0.5+1.0	0.5+1.0	f/1 MHz*1.5 + f/1 MHz*1.5	
Voltage U _{SENSOR}	0.02+0.08	0.015+0.03	0.01+0.02	0.03+0.06	0.2+0.4		0.4+0.8	0.4+0.8	f/1 MHz*0.7 + f/1 MHz*1.5	
Current I* 5 mA ... 5 A	0.02+0.1	0.015+0.03	0.01+0.02	0.03+0.06	0.2+0.4		0.5+1.0	0.5+1.0	f/1 MHz*1.0 + f/1 MHz*2.0	-
Current I* 10 A ... 32 A	0.02+0.1 ¹⁾	0.015+0.03 ³⁾	0.01+0.02 ³⁾	0.1+0.2 ³⁾	0.3+0.6 ³⁾	f/100 kHz*0.8 + f/100 kHz*1.2 ³⁾		-	-	-
Current I _{SENSOR}	0.02+0.08	0.015+0.03	0.01+0.02	0.03+0.06	0.2+0.4		0.4+0.8	0.4+0.8	f/1 MHz*0.7 + f/1 MHz*1.5	
Power U*/I* 5 mA ... 5 A	0.032+0.09	0.024+0.03	0.015+0.01	0.048+0.06	0.32+0.4		0.8+1.0	0.8+1.0	f/1 MHz*2.0 + f/1 MHz*1.8	-
Power U*/I* 10 A ... 32 A	0.032+0.09 ²⁾	0.024+0.03 ⁴⁾	0.015+0.01 ⁴⁾	0.104+0.13 ⁴⁾	0.4+0.5 ⁴⁾	f/100 kHz*0.8 + f/100 kHz*0.8 ⁴⁾	f/100 kHz*1.0 + f/100 kHz*1.1 ⁴⁾	-	-	-
Power U*/I _{SENSOR}	0.032+0.08	0.024+0.03	0.015+0.01	0.048+0.06	0.32+0.4		0.72+0.9	0.72+0.9	f/1 MHz*1.8 + f/1 MHz*1.5	
Power U _{SENSOR} /I* 5 mA ... 5 A	0.032+0.09	0.024+0.03	0.015+0.01	0.048+0.06	0.32+0.4		0.72+0.9	0.72+0.9	f/1 MHz*1.4 + f/1 MHz*1.8	-
Power U _{SENSOR} /I* 10 A ... 32 A	0.032+0.09 ²⁾	0.024+0.03 ⁴⁾	0.015+0.01 ⁴⁾	0.104+0.13 ⁴⁾	0.4+0.5 ⁴⁾	f/100 kHz*0.8 + f/100 kHz*0.8 ⁴⁾	f/100 kHz*1.0 + f/100 kHz*1.0 ⁴⁾	-	-	-
Power U _{SENSOR} /I _{SENSOR}	0.032+0.08	0.024+0.03	0.015+0.01	0.048+0.06	0.32+0.4		0.64+0.8	0.64+0.8	f/1 MHz*1.1 + f/1 MHz*1.5	

LMG610-B1 Accuracy	± (% of measured value + % of maximum peak value)						
	DC	0.05 Hz ... 45 Hz 65 Hz ... 1 kHz	45 Hz ... 65 Hz	1 kHz ... 5 kHz	5 kHz ... 20 kHz	20 kHz ... 100 kHz	100 kHz ... 500 kHz
Voltage U*	0.1+0.1	0.1+0.1	0.03+0.03	0.2+0.2	0.3+0.4	0.4+0.8	f/100 kHz*0.8 + f/100 kHz*1.2
Current I* 5 mA ... 5 A Current I _{SENSOR}	0.1+0.1	0.1+0.1	0.03+0.03	0.2+0.2	0.3+0.4	0.4+0.8	f/100 kHz*0.8 + f/100 kHz*1.2
Current I* 10 A ... 32 A	0.1+0.1 ¹⁾	0.1+0.1 ³⁾	0.03+0.03 ³⁾	0.2+0.2 ³⁾	0.6+1.2 ³⁾	1.5+1.5 ³⁾	f/100 kHz*2.0 + f/100 kHz*2.0 ³⁾
Power U*/I* 5 mA ... 5 A Power U*/I _{SENSOR}	0.16+0.1	0.16+0.1	0.05+0.02	0.32+0.2	0.48+0.4	0.64+0.8	f/100 kHz*1.28 + f/100 kHz*1.2
Power U*/I* 10 A ... 32 A	0.16+0.1 ²⁾	0.16+0.1 ⁴⁾	0.05+0.02 ⁴⁾	0.32+0.2 ⁴⁾	0.72+0.8 ⁴⁾	1.52+1.15 ⁴⁾	f/100 kHz*2.24 + f/100 kHz*1.6 ⁴⁾

LMG610-C1 Accuracy	± (% of measured value + % of maximum peak value)						
	DC	0.05 Hz ... 45 Hz 65 Hz ... 200 Hz	45 Hz ... 65 Hz	200 Hz ... 500 Hz	500 Hz ... 1 kHz	1 kHz ... 2 kHz	2 kHz ... 10 kHz
Voltage U*	0.1+0.1	0.02+0.05	0.02+0.02	0.05+0.05	0.2+0.1	1.0+0.5	f/1 kHz*1.0 + f/1 kHz*1.0
Current I*	0.1+0.1 ¹⁾	0.02+0.05 ³⁾	0.02+0.02 ³⁾	0.05+0.05 ³⁾	0.2+0.1 ³⁾	1.0+0.5 ³⁾	f/1 kHz*1.0 + f/1 kHz*1.0 ³⁾
Current I _{SENSOR}	0.1+0.1	0.02+0.05	0.02+0.02	0.05+0.05	0.2+0.1	1.0+0.5	f/1 kHz*1.0 + f/1 kHz*1.0
Power	0.16+0.1 ²⁾	0.032+0.05 ⁴⁾	0.03+0.01 ⁴⁾	0.08+0.05 ⁴⁾	0.32+0.1 ⁴⁾	1.6+0.5 ⁴⁾	f/1 kHz*1.6 + f/1 kHz*1.0 ⁴⁾

Accuracies valid for:	1. Sinusoidal voltages and currents 2. Ambient temperature (23±3) °C 3. Warm-up time 1 h 4. The upper range value is defined by the maximum peak value. 5. The upper power range value is the product of upper voltage range value and upper current range value.	6. $0 \leq \lambda \leq 1$ (power factor) 7. Current and voltage 10% ... 110% of nominal value 8. Adjustment carried out at 23 °C 9. Calibration interval 12 months
Other values	All other values are calculated from current, voltage and power. Accuracy resp. error limits are derived according to context (e.g. $S = I * U$, $\Delta S / S = \Delta I / I + \Delta U / U$).	









¹⁾ ²⁾ ³⁾ ⁴⁾ only valid in range 10 ... 32 A:

¹⁾ additional uncertainty $\pm \frac{50 \mu A}{A^2} * I_{rms}^2$ ²⁾ additional uncertainty $\pm \frac{50 \mu A}{A^2} * I_{rms}^2 * U_{rms}$ ³⁾ additional uncertainty $\pm \frac{30 \mu A}{A^2} * I_{rms}^2$ ⁴⁾ additional uncertainty $\pm \frac{30 \mu A}{A^2} * I_{rms}^2 * U_{rms}$

Voltage measuring ranges U*														
Nominal value (V)	3	6	12.5	25	60	130	250	400	600	1000				
Max. trms value (V)	3.3	6.6	13.8	27.5	66	136	270	440	660	1000				
Max. peak value (V)	6	12	25	50	100	200	400	800	1600	3200				
Overload protection	1000V + 10% permanently, 1500V for 1s													
Input impedance	4.59 MΩ, 3 pF													
Earth capacitance	90 pF													
Current measuring ranges I*														
Nominal value (A)	0.005	0.01	0.02	0.04	0.08	0.15	0.3	0.6	1.2	2.5	5	10	20	32
Max. trms value (A)	0.0055	0.011	0.022	0.044	0.088	0.165	0.33	0.66	1.32	2.75	5.5	11	22	32
Max. peak value (A)	0.014	0.028	0.056	0.112	0.224	0.469	0.938	1.875	3.75	7.5	15	30	60	120
Input impedance	ca. 2.2 Ω		ca. 600 mΩ			ca. 80 mΩ			ca. 20 mΩ			ca. 10 mΩ		
Overload protection permanent (A)	LMG in operation 10 A							LMG in operation 32 A						
Overload protection short-time (A)	150 A for 10 ms													
Earth capacitance	90 pF													
Sensor inputs U_{SENSOR} I_{SENSOR}														
Nominal value (V)	0.03	0.06	0.12	0.25	0.5	1	2	4						
Max. trms value (V)	0.033	0.066	0.132	0.275	0.55	1.1	2.2	4.4						
Max. peak value (V)	0.0977	0.1953	0.3906	0.7813	1.563	3.125	6.25	12.5						
Overload protection	100V permanently, 250V for 1s													
Input impedance	100 kΩ, 34 pF													
Earth capacitance	90 pF													
Isolation	All current and voltage inputs are isolated against each other, against remaining electronics and against earth Max. 1000V / CAT III resp. 600V / CAT IV													
Synchronization	Measurements are synchronized on the signal period. The period is determined based on „line“, „external“, u(t) or i(t), in combination with configurable filters. Therefore readings are very stable, especially with PWM controlled frequency converters and amplitude modulated electronic loads.													
Scope function	Graphical display of sample values over time in two scopes 8 signals each													
Plot function	Two time (trend-) diagrams of max. 8 parameters, max. resolution 30 ms													
Harmonics at device level (L6-OPT-HRM)	Harmonics and interharmonics up to 2,000. order													
Flicker (L6-OPT-FLK)	According to EN 61000-4-15													
LMG Remote	LMG600 expansion software, basic module for remote configuration and operation via PC, included in the standard delivery													
LMG Test Suite	LMG600 software for conformity tests according to EN61000 for harmonics and flicker													
Miscellaneous	Dimensions Table-top version: (WxHxD) 455 mm x 224 mm x 200 mm Weight Depending on installed options: max. 7.2 kg Protection class EN 61010 (IEC 61010, VDE 0411), protection class I / IP20 in accordance with EN 60529 Electromagnetic compatibility EN 61326 Temperature 0 ... 40 °C (operation) / -20 ... 50 °C (storage) Climatic category Normal environmental conditions according to EN 61010 Line input 100 ... 230 V, 47 ... 63 Hz, max. 200 W													

The full technical data can be found in the manual.

Accessories program (excerpt)

Current sensors										
Type	Ring-type transducers					Current clamps		Flexible	Shunt	
										
Name	PCT	L60-Hall	DS5000	LMG-Z601	LMG-Z500	LMG-Z406, L45-Z10/16	L45-Z26	L60-Flex	LMG-SH (-P)	
Signal type	AC+DC			AC		AC	AC+DC	AC	AC+DC	
Current ranges	60...2000 A _{rms}	50...2000 A _{rms}	60...5000 A _{rms}	100 A _{rms}	0.1 ... 10 kA _{rms}	40...3 kA _{rms}	30...1 kA _{rms}	500 ... 3 kA _{rms}	37mA...0.6 A _{rms}	
Best accuracy	0.015 %	0.3 %	0.07 %	0.15 %	0.02 %	0.1 %	1.5 %	2 %	0.15 %	
Max. bandwidth	0 Hz...1 MHz	0 Hz... 150 kHz	0 Hz... 10 kHz	30 Hz... 1 MHz	5 Hz... 15 kHz	2 Hz... 50 kHz	0 Hz... 2 kHz	10 Hz... 5 kHz	45 ... 65 Hz	
Power supply by LMG610	Yes		No	Not required		Yes		Not required		
Plug 'n' measure	Yes		No	No		Yes		No		

High-voltage dividers



Name	HST-3	HST-6	HST-9	HST-12
Signal type	AC+DC			
Max. voltage	3.15 kV _{rms}	6.3 kV _{rms}	9.45 kV _{rms}	12.6 kV _{rms}
Best accuracy	0.05 %			
Max. bandwidth	0 Hz... 300 kHz			
Number of phases	1 to 3			
Plug 'n' measure	no			

Breakout box



Name	LMG-MAS	LMG-MAK1
Nominal voltage	250 V	300 V
Category	CAT III	
Safety standard	IEC / EN61010-1	
Socket for load connection	16 A 250 V CEE 7/4	10 A 250 V IEC 60320-C14

The Breakout Boxes enable access to the individual lines in a connector for measurement and provides an easy and elegant way to take measurements on single and three-phase loads.

LMG Remote



The LMG Remote PC software allows to easily control the LMG610 remotely from a Windows PC. Since this software mimicks the measuring device itself down to the last detail, the LMG610 can be operated as usual, even from the PC - no rethinking required, no familiarization time.

LMG Test Suite



The tests performed by LMG Test Suite are in accordance with the currently valid edition of EN 61000-3-2/-12 or EN 61000-3/-11, and measurements according to ECE R-10.4 Annex 11 (electromagnetic compatibility of vehicles), for example, are also possible.